

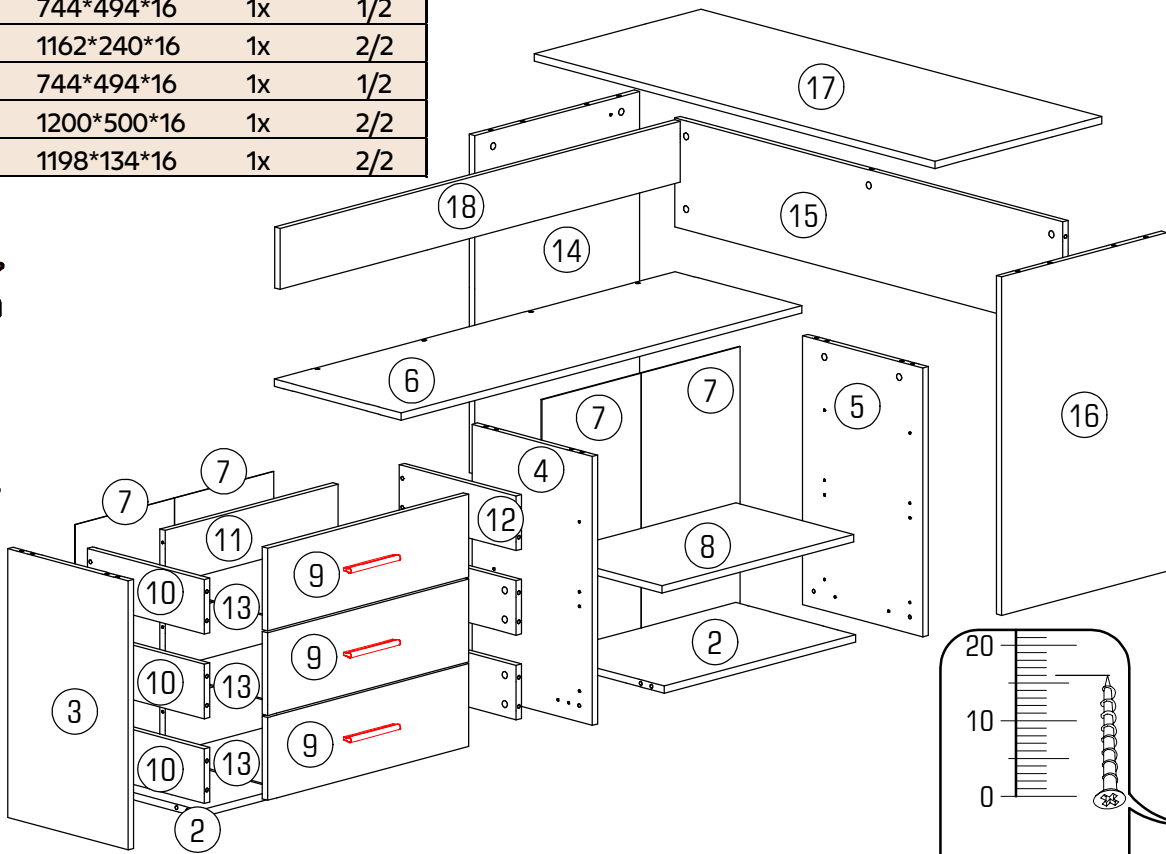

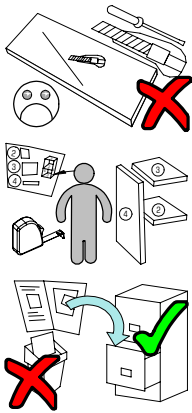

ID	ID			
21501	②	574*359*16	2x	2/2
21502	③	591*360*16	1x	1/2
21503	④	591*360*16	1x	1/2
21504	⑤	591*360*16	1x	1/2
21505	⑥	1200*380*16	1x	2/2
21506	⑦	574*297*3	4x	1/2
21507	⑧	574*353*16	1x	1/2
21508	⑨	602*182*16	3x	1/2
19025	⑩	350*120*16	3x	2/2
21509	⑪	518*120*16	3x	2/2 1/2
19027	⑫	350*120*16	3x	2/2
21510	⑬	548*356*3	3x	1/2
21511	⑭	744*494*16	1x	1/2
21512	⑮	1162*240*16	1x	2/2
21513	⑯	744*494*16	1x	1/2
21514	⑰	1200*500*16	1x	2/2
21515	⑱	1198*134*16	1x	2/2

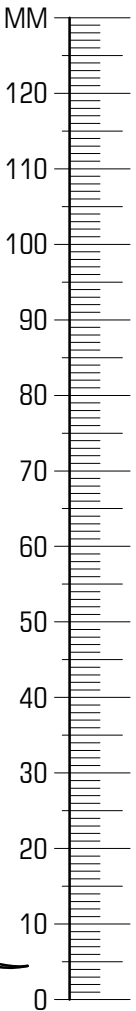
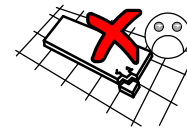
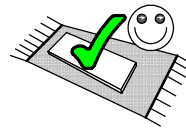
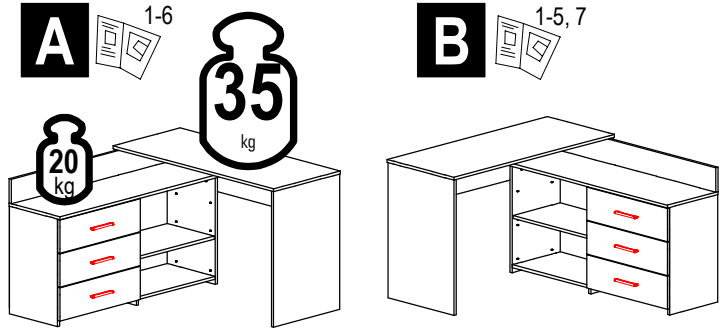
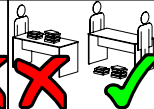
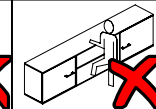
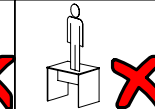
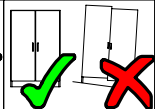
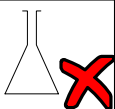

8501.00		22244.01		30091.00		27000.00		70013.01		70021.01		22300.00		22705.00	
A	4x	B	15x	C	10x	D	18x	E	11x	F	35x	G	35x	H	16x
22243.00		22236.00		21102.00		33006.01		33006.01		22280.00		24008.00		32030.00	
K	24x	L	16x	M	6x	N	50x	P	3x	Q	3x	R	6x	S	6x
														T	3x

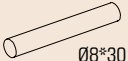

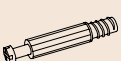

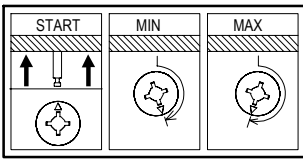
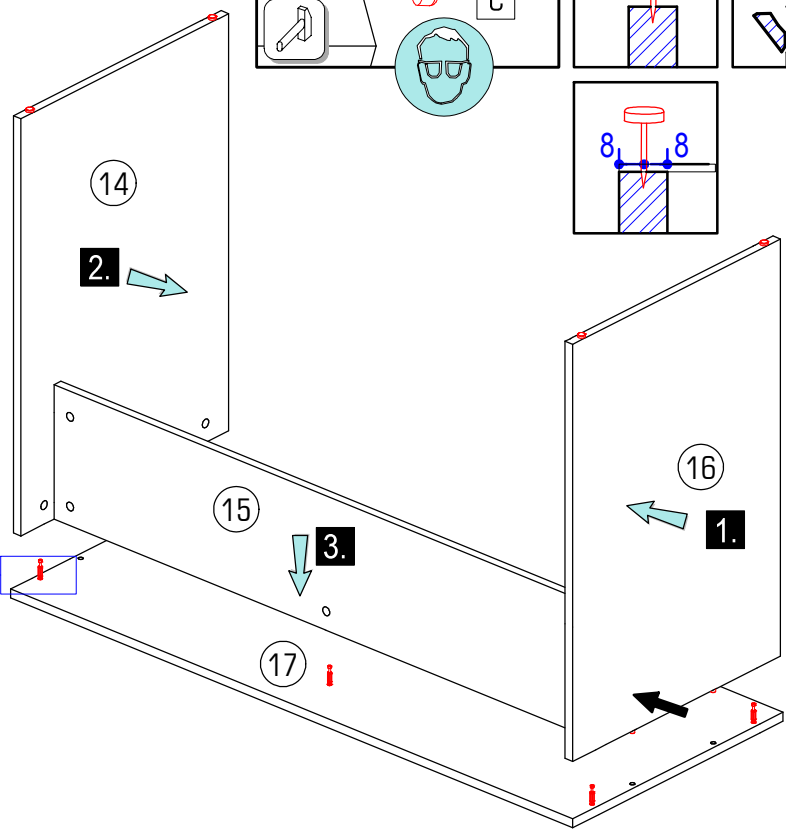
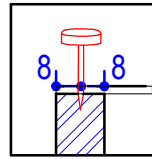
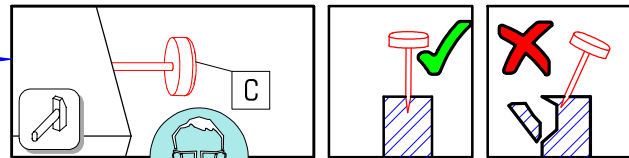
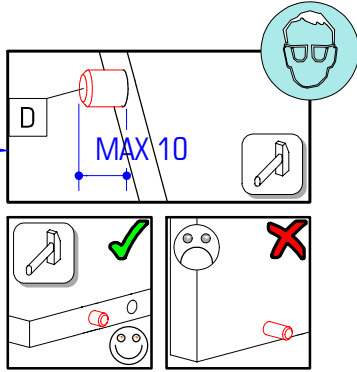
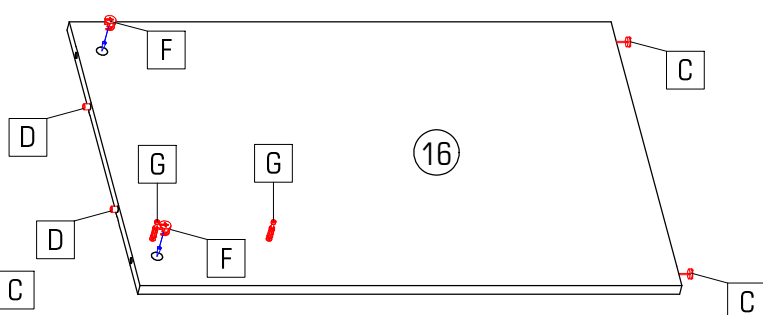
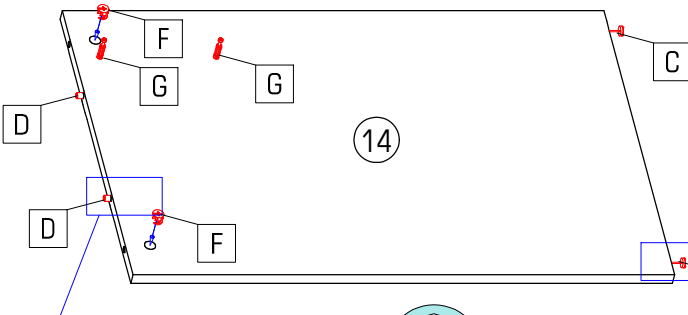
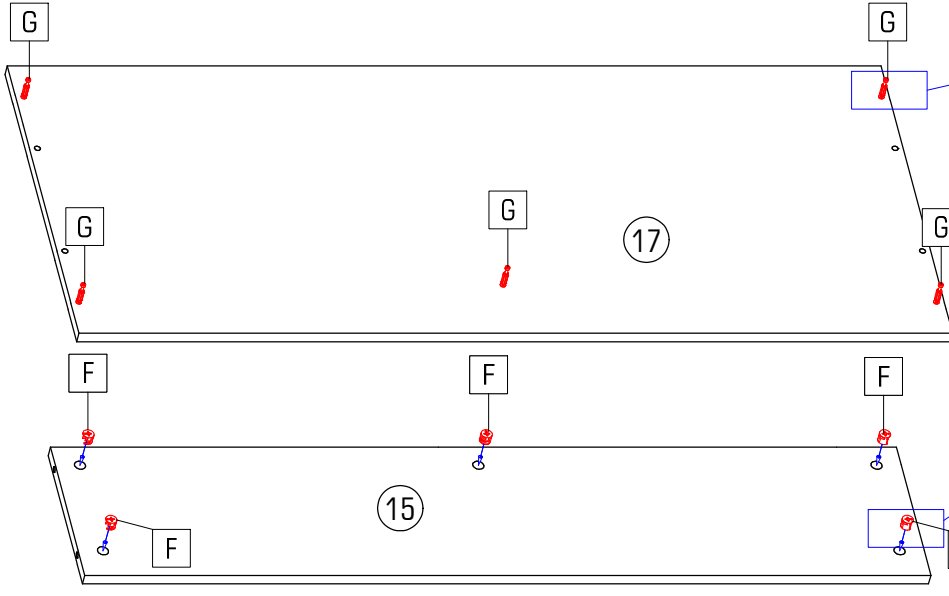
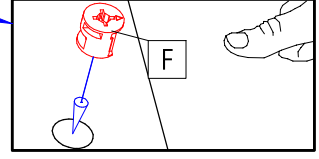
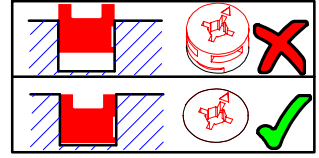
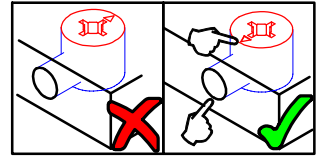
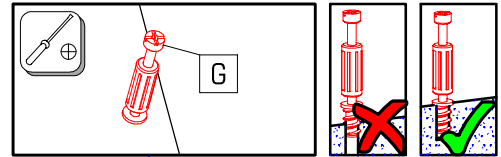



			
C 4x	D 4x	F 9x	G 9x

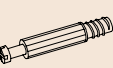
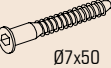

2.

3.

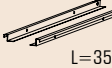
1.

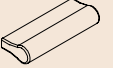

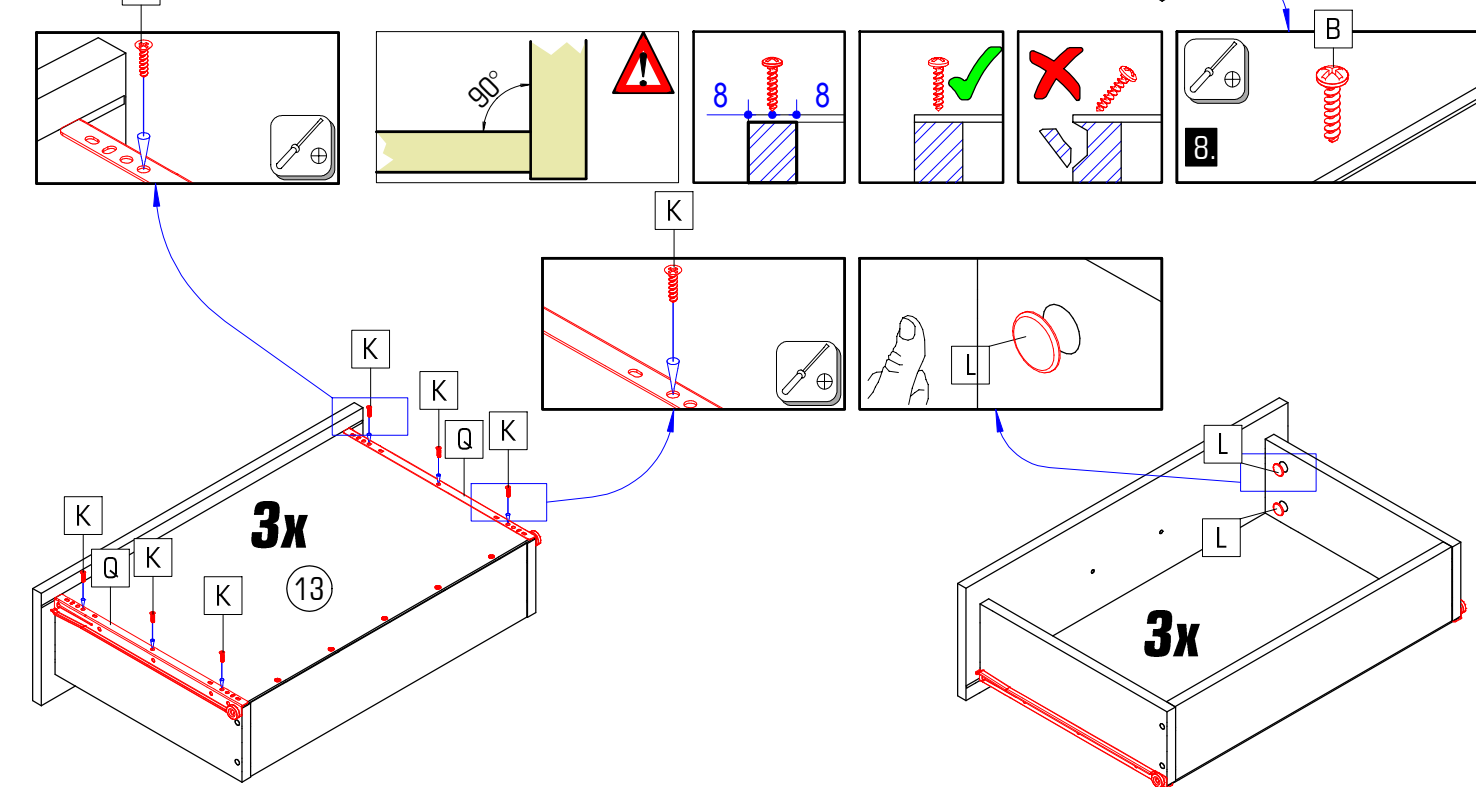
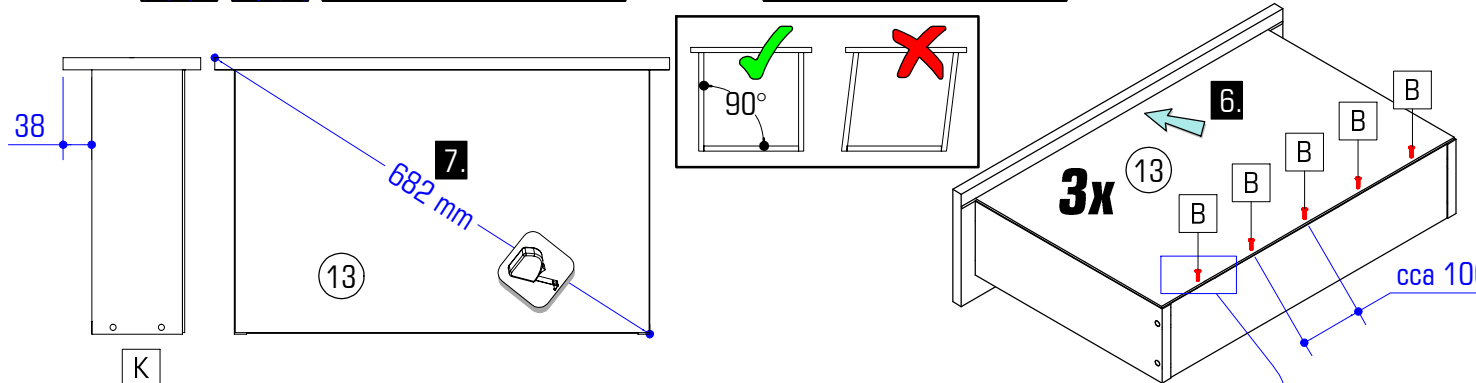
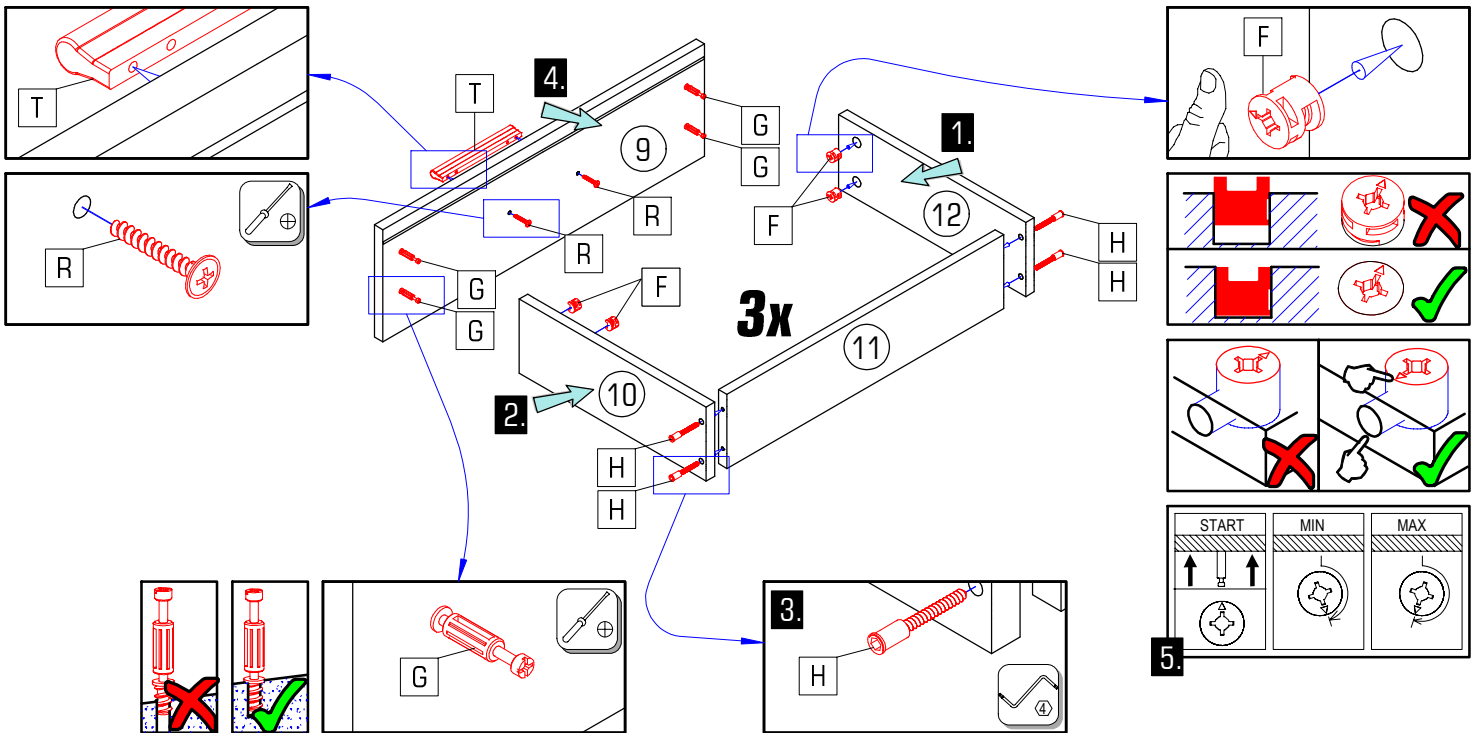
								
B 15x	L 12x	F 12x	G 12x	H 12x	K 18x	Q 3x	R 6x	T 3x

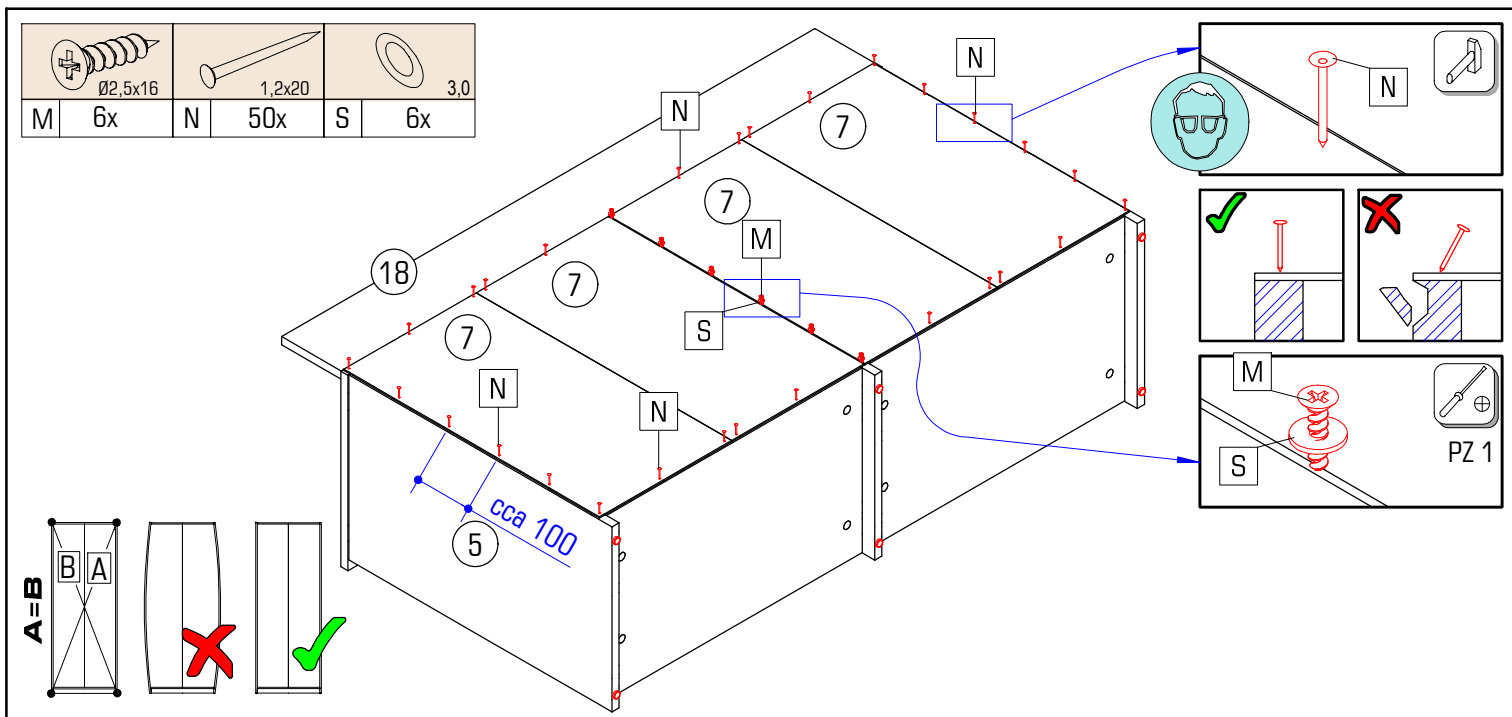
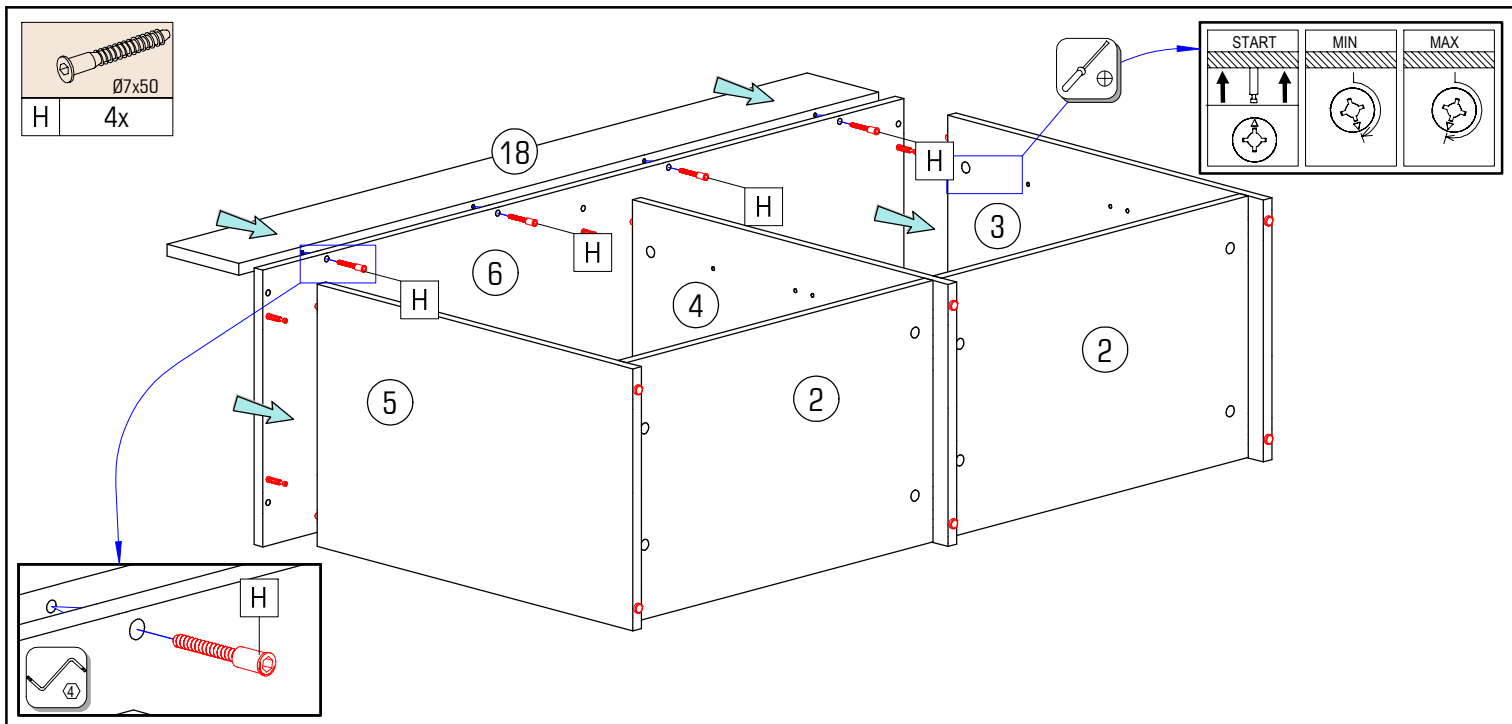
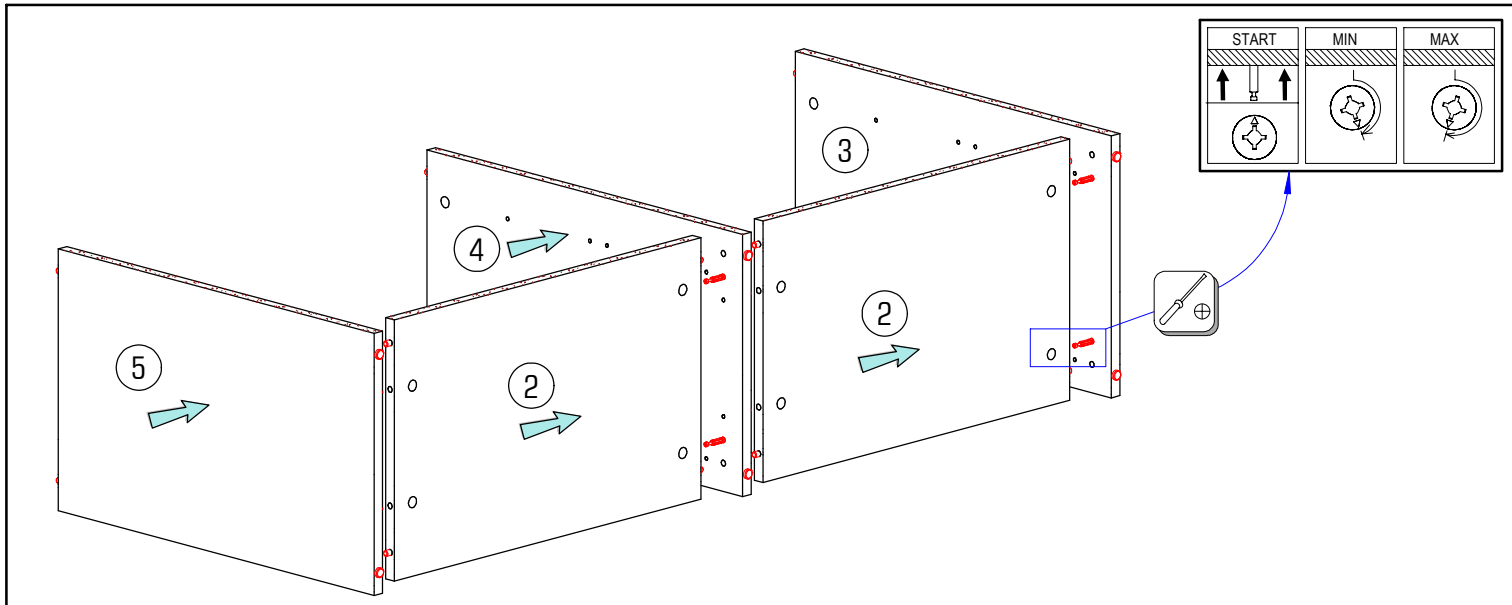



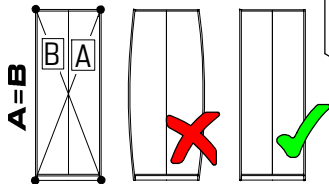

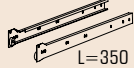

Ø2,5x16	1,2x20	3,0
M 6x	N 50x	S 6x

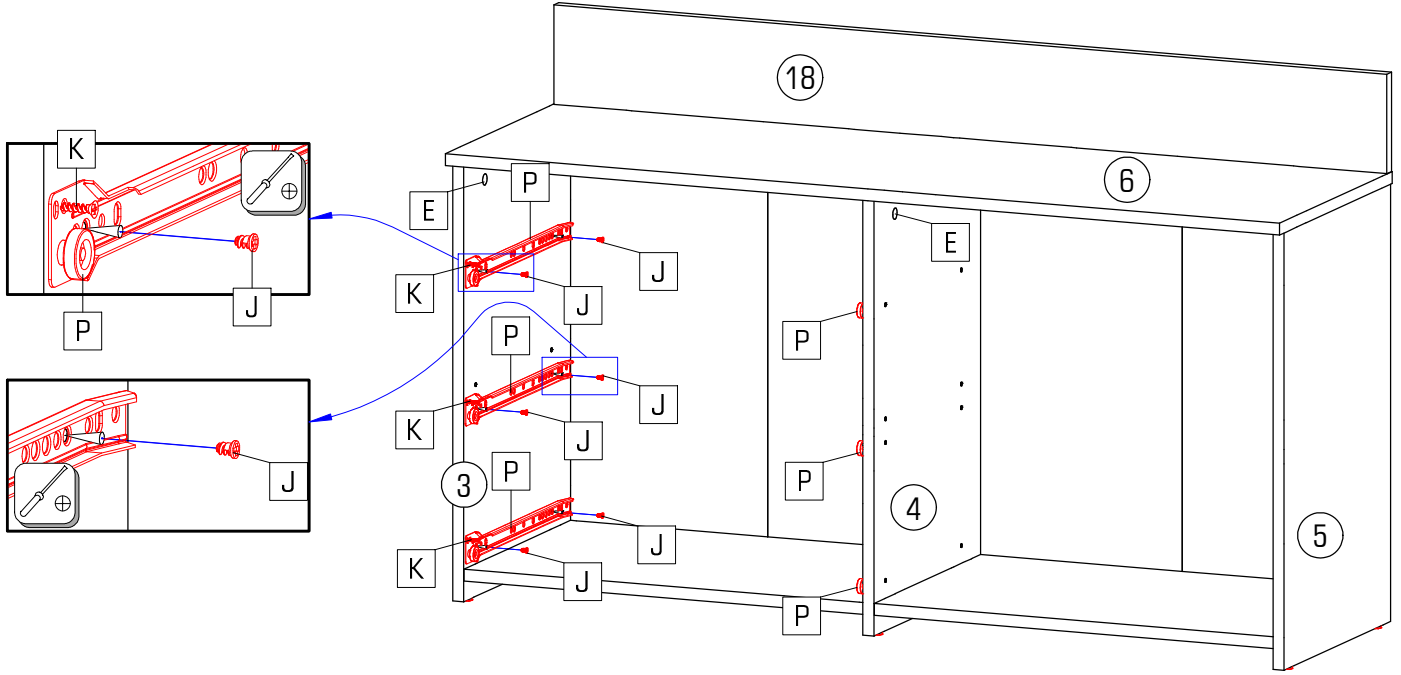



			
E 4x	J 12x	K 6x	P 3x
	Ø6,3x8	Ø3,5x15	L=350



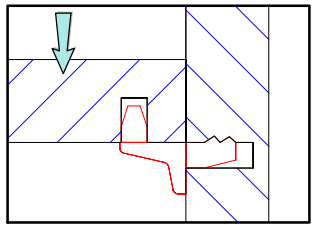
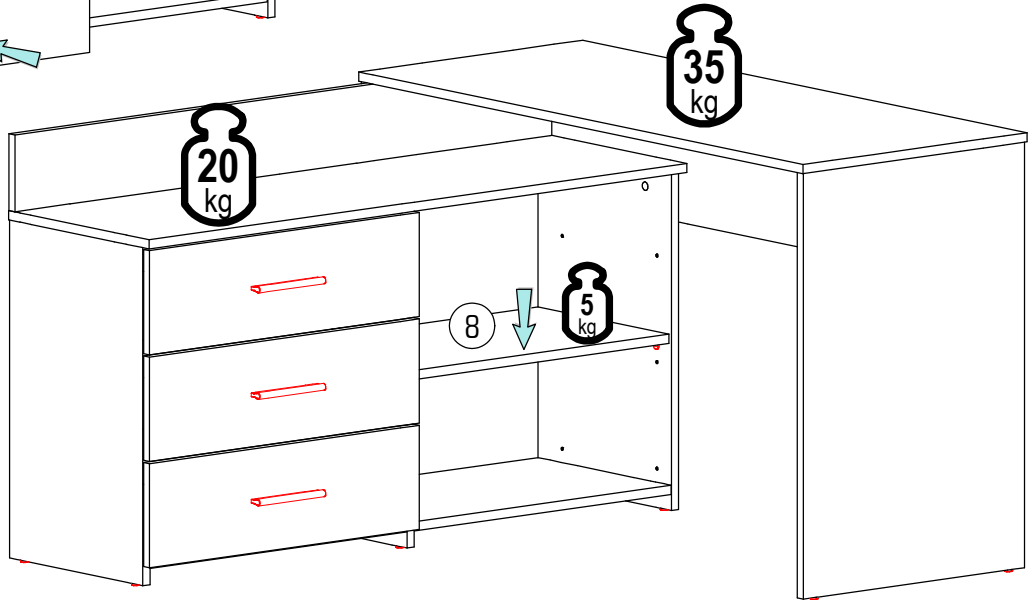
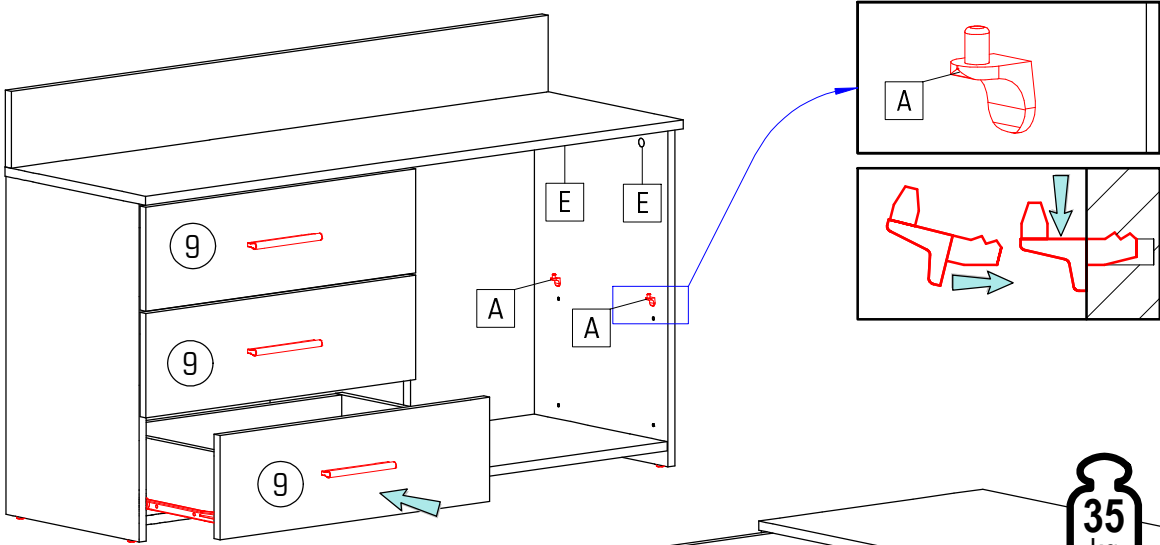

		
A 4x	E 7x	L 4x

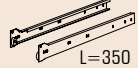

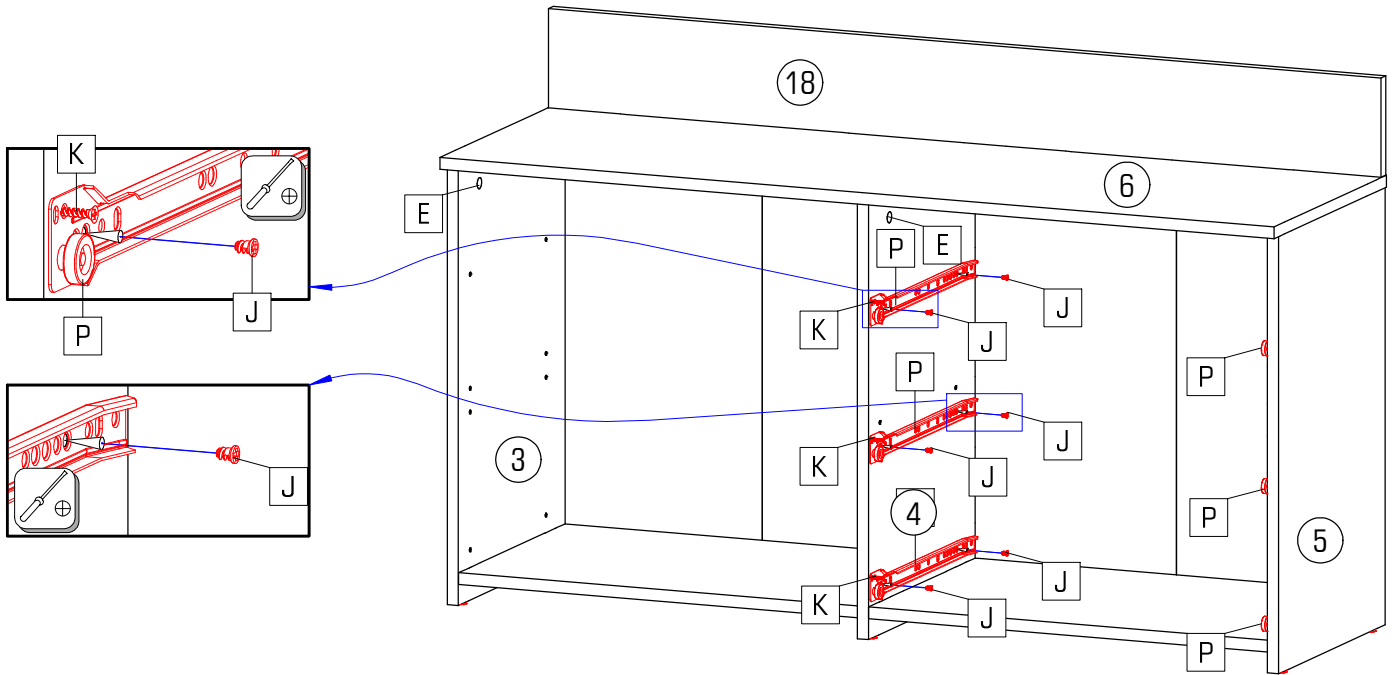
			
E 4x	J 12x	K 6x	P 3x
			L=350



		
A 4x	E 7x	L 4x

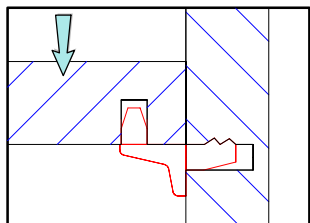
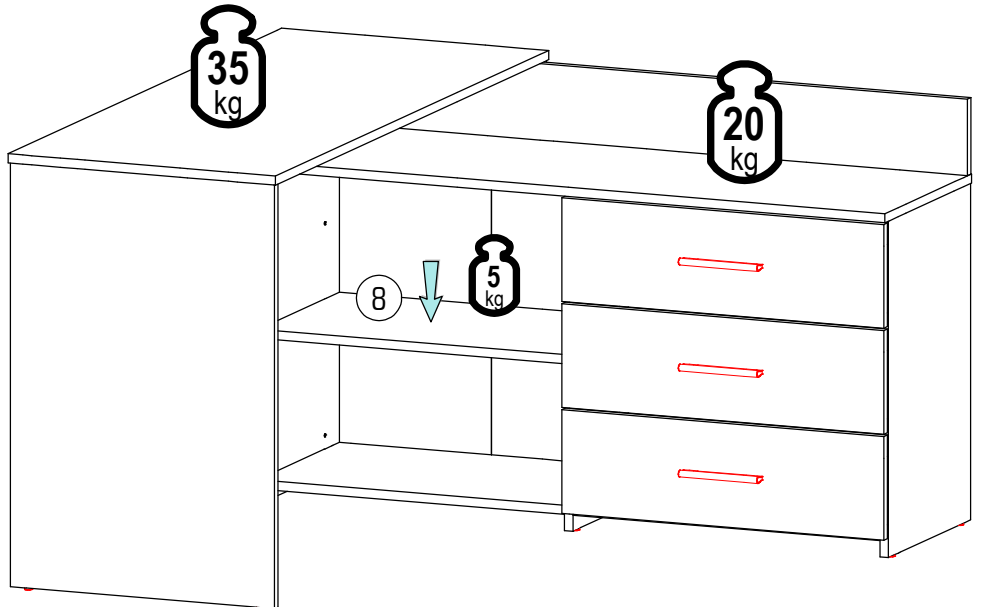
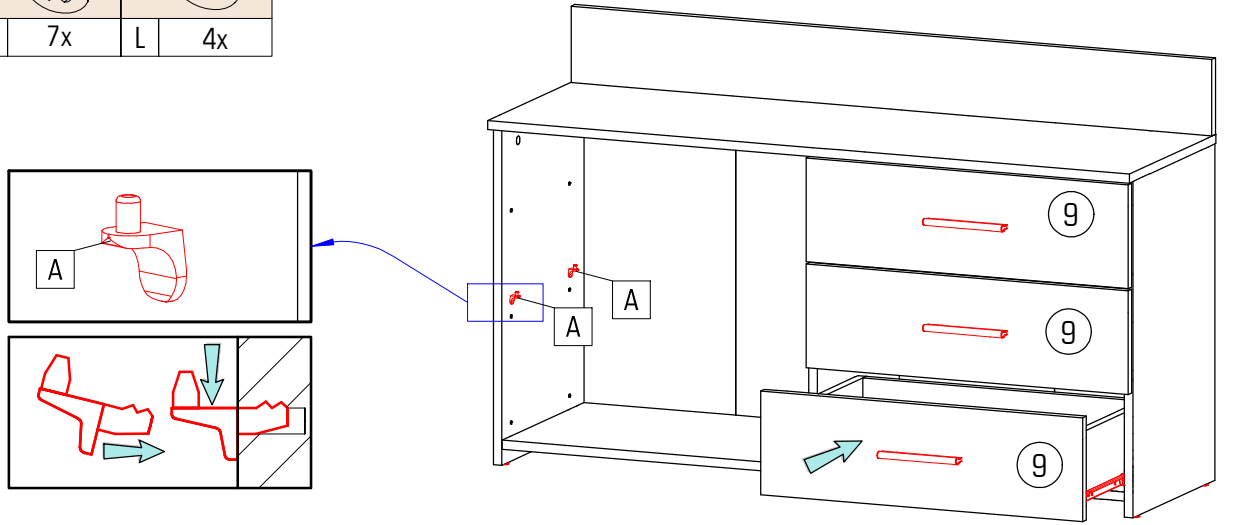

A

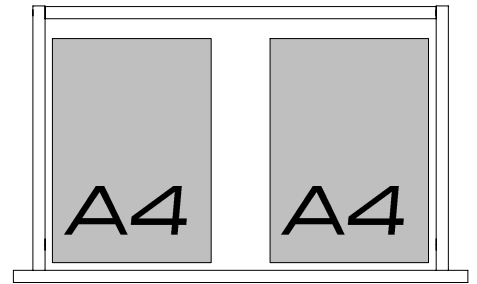
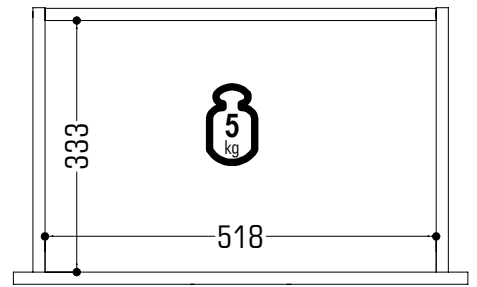
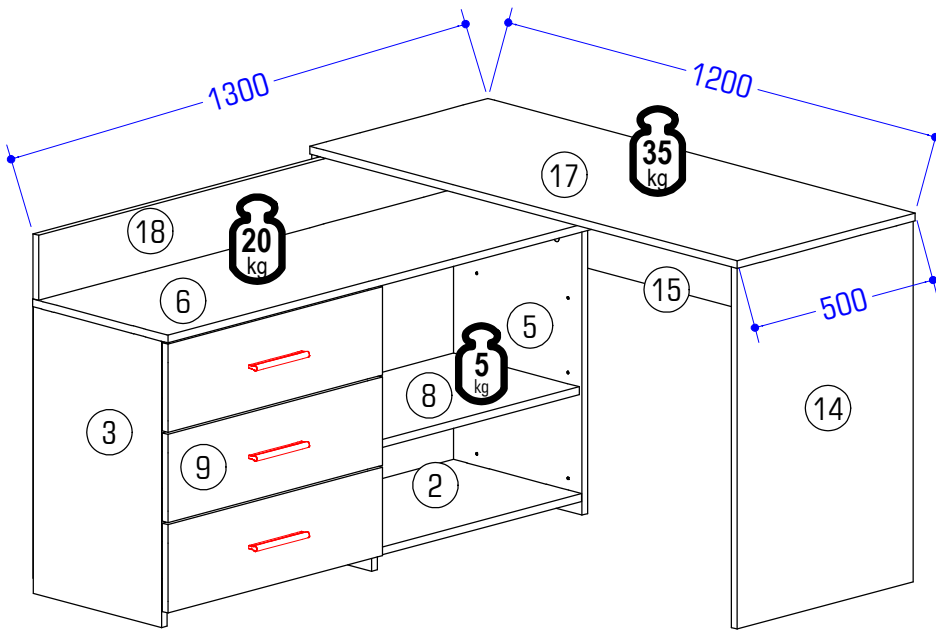

B

